

# FLAT TOP TOWER CRANE









**Specifications:**

- ▶ Max jib length: 80,00 m
- ▶ Capacity at max length: 4,00 t
- ▶ Max capacity: 20,00 t

**WORKS FOR YOU.™**

# KEY

## Zeichenerklärung · Légende · Leyenda · Legenda · Legenda · Условные обозначения

	Hoisting · Heben · Levage · Elevación · Sollevamento · Elevação · Подъем
	Trolleying · Katzfahren · Distribution · Distribución · Traslazione carrello · Distribuição · Передвижение каретки
	Slewing · Schwenken · Orientation · Orientació · Rotazione · Giro · Поворот
	Travelling · Schienenfahren · Translation · Traslación · Traslazione · Móvel · Передвижение
	Directive on noise level · Richtlinie für den Schall-Leistungspegel · Directive sur le niveau acoustique · Directiva sobre el nivel acústico · Direttiva sul livello acústico · Directiva sobre nivel de ruidos · Директива по уровню шума
	Consult us · Auf Anfrage · Nous consulter · Consultarnos · Consultateci · Consulte-nos · Проконсультироваться с нами
	Power requirements · Geforderte Stromstärke · Puissance totale nécessaire · Potencia necesaria · Potenza totale richiesta · Requisitos de energia · Требования по питанию
	Power supply · Stromversorgung · Alimentation · Alimentación · Alimentazione · Fonte de alimentação · Питание
	In service · In Betrieb · En service · En servicio · In servizio · Em serviço · При работе
	Out of service · Außer Betrieb · Hors service · Fuera de servicio · Fuori servizio · Fora de serviço · В режиме простоя
	Max. under hook height · Höchste Hakenhöhe · Hauteur maxi. sous crochet · Maxima altura bajo gancho · Altezza max. sotto gancio · Alt. máx. sob o gancho · Макс высота крюка
	Without load, without ballast, max. jib and max. height · Ohne Last und Ballast, mit Maximalausleger und Maximalhöhe · A vide, sans lest, avec flèche et hauteur maximum · Sin carga, sin lastre, con pluma y altura máxima · A vuoto, senza zavorra, braccio max., altezza max. · Sem carga, sem lastro, lança máxima, altura máxima · Без груза, без балласта, на макс. Длине вспомогательной стрелы и макс. Высоте
	Counterweight · Gegengewicht · Lest de contre-flèche · Lastre de contra flecha · Zavorra controbraccio · Contrapeso · Противовес
<b>C25</b>	EN 14439-C25 · EN 14439 - C25 · EN14439 - C25 · EN 14439 - C25 · EN 14439 - C25 · EN 14439 - C25 · EN14439 - C25

# CONTENTS

СТТ 472-20

Inhalt · Contenu · Contenido · Indice · Sumário · Содержание

Page · Seite · Page · Página · Pagina · Página · Страница:

Load Diagram · Lastkurven · Courbes de charges · Curvas de cargas · Diagramma di portata · Diagrama de carga · Диаграмма грузоподъёмности .....	4
Tower · Turm · Tour · Torre · Torre · Torre · Башня.....	8
Mechanisms · Antriebe · Mécanismes · Mecanismos · Meccanismi · Mecanismo · Механизм .....	14
Transportation · Transport · Transport · Transporte · Trasporto · Transporte · Транспортировка.....	16

# LOAD DIAGRAM

Lastkurven · Courbes de charges · Curvas de cargas · Diagramma di portata · Diagrama de carga · Диаграмма грузоподъёмности

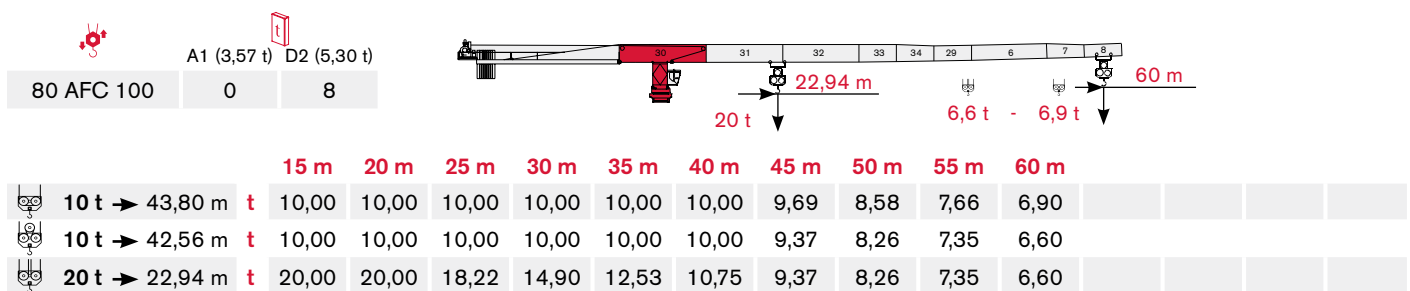
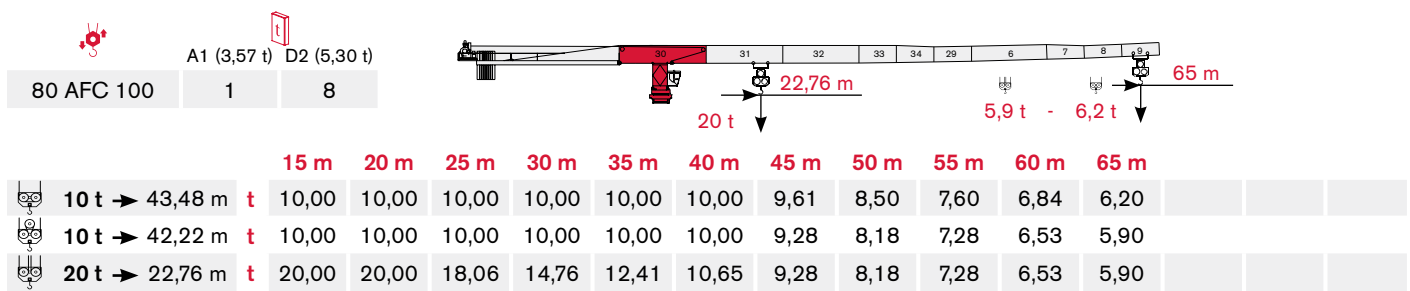
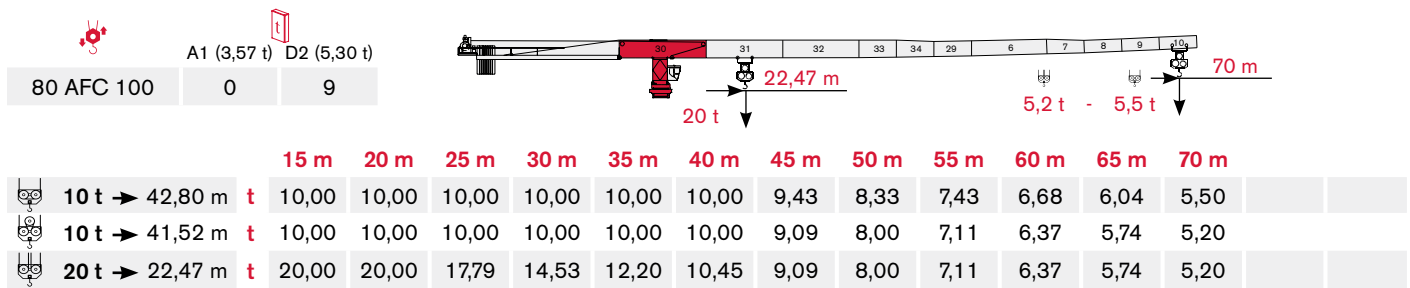
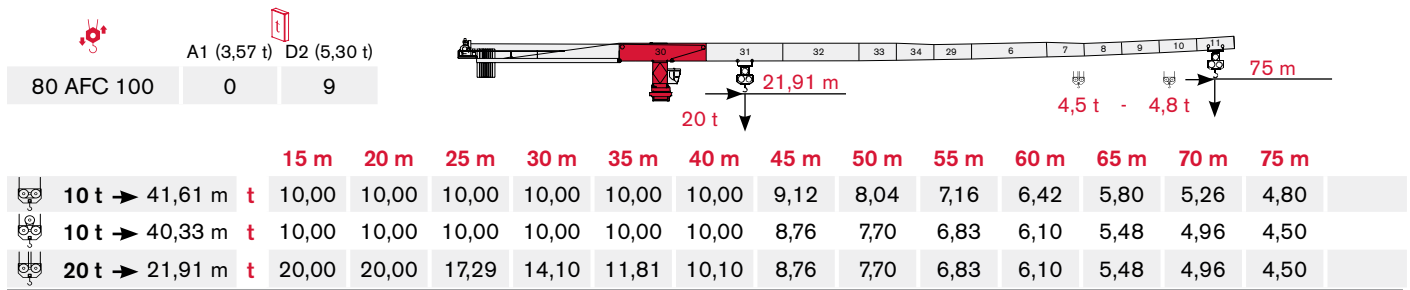
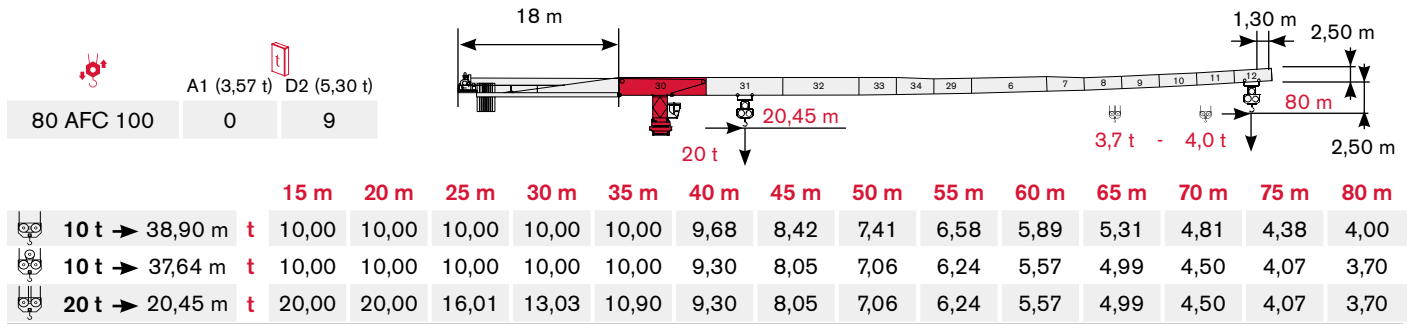

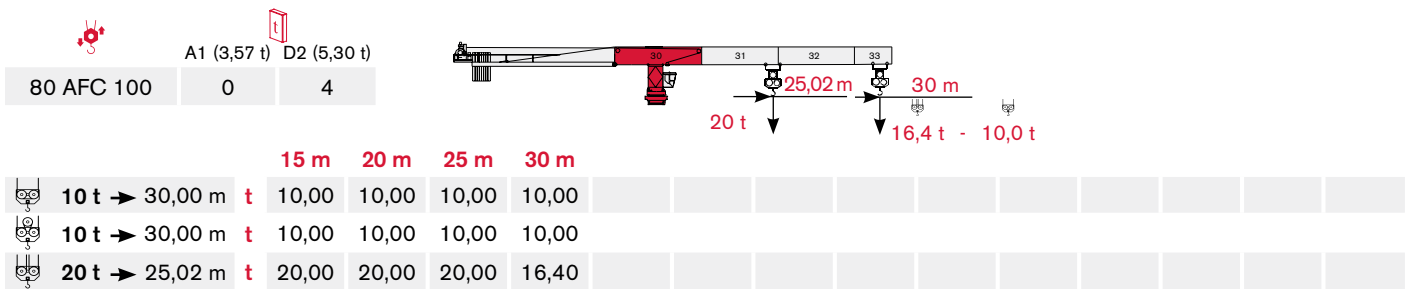
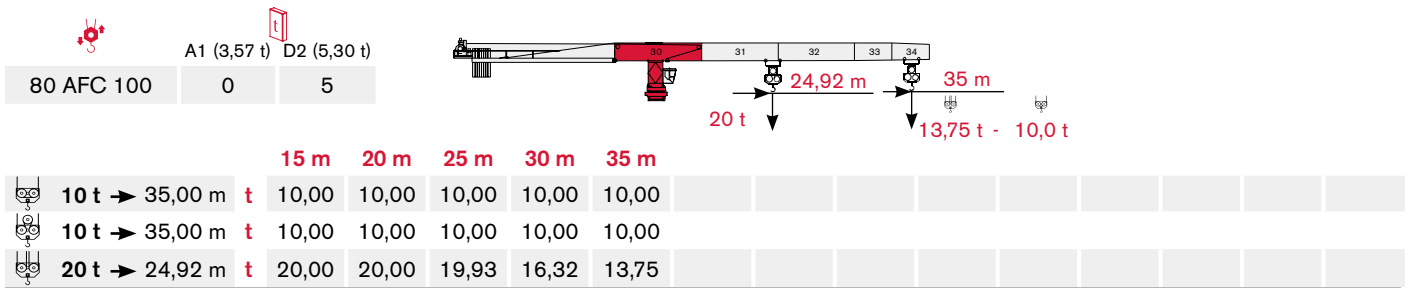
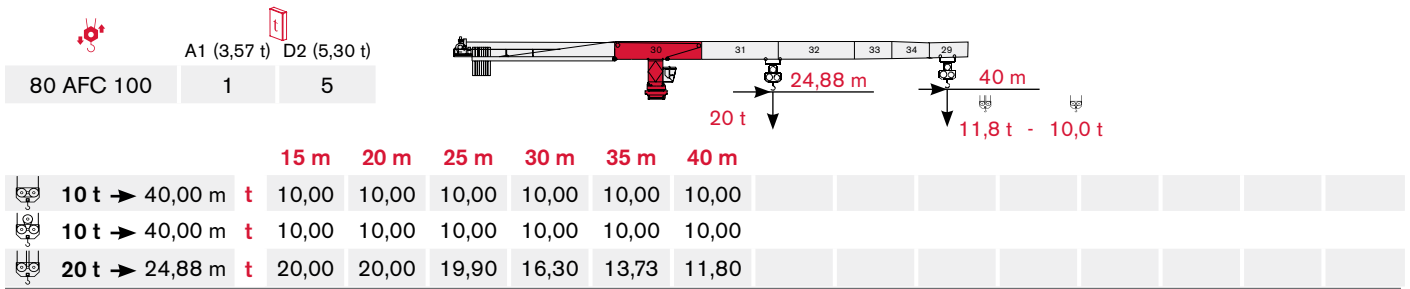
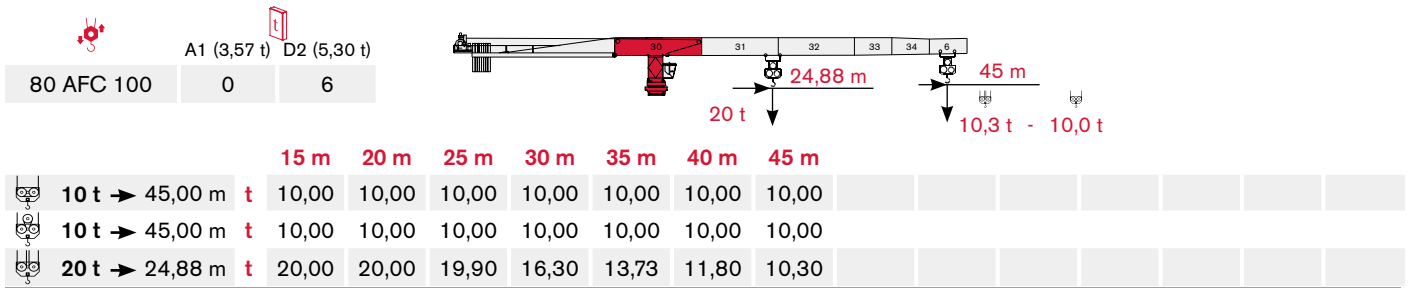
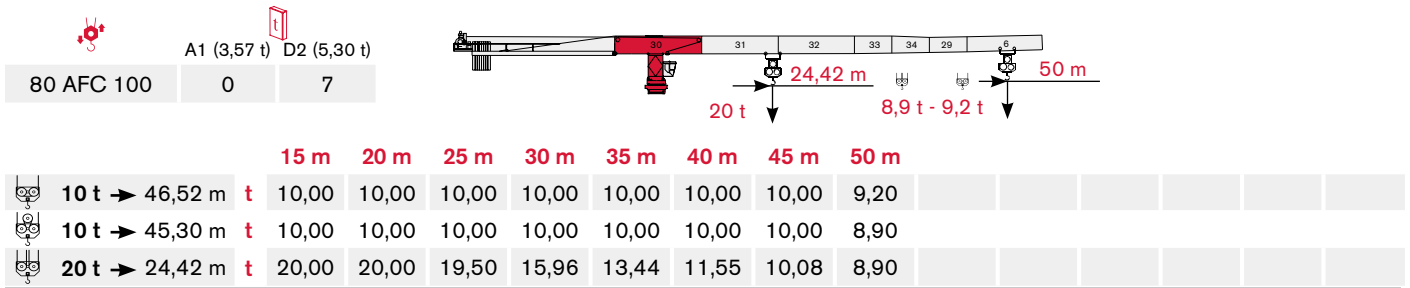
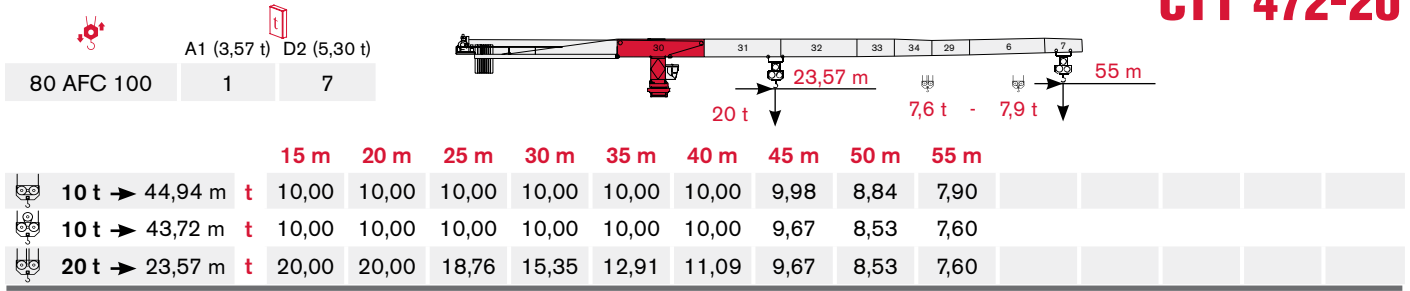

# LOAD DIAGRAM

Lastkurven · Courbes de charges · Curvas de cargas · Diagramma di portata · Diagrama de carga · Диаграмма грузоподъёмности

## TEREX POWER PLUS

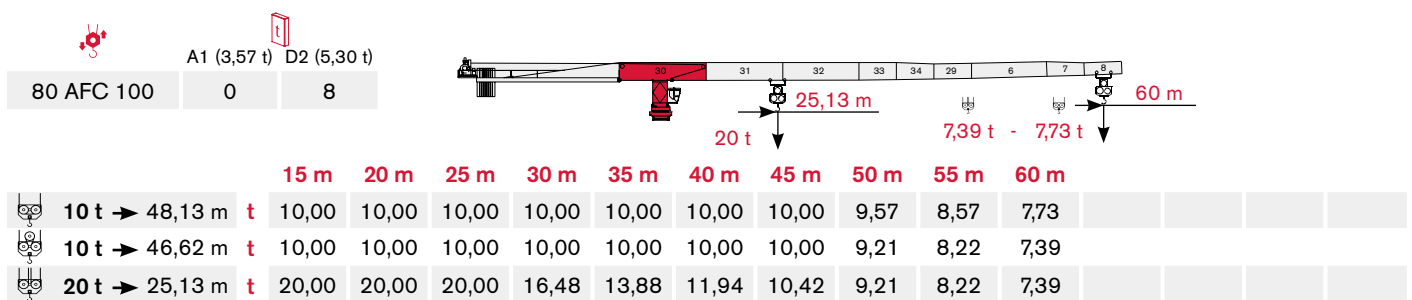
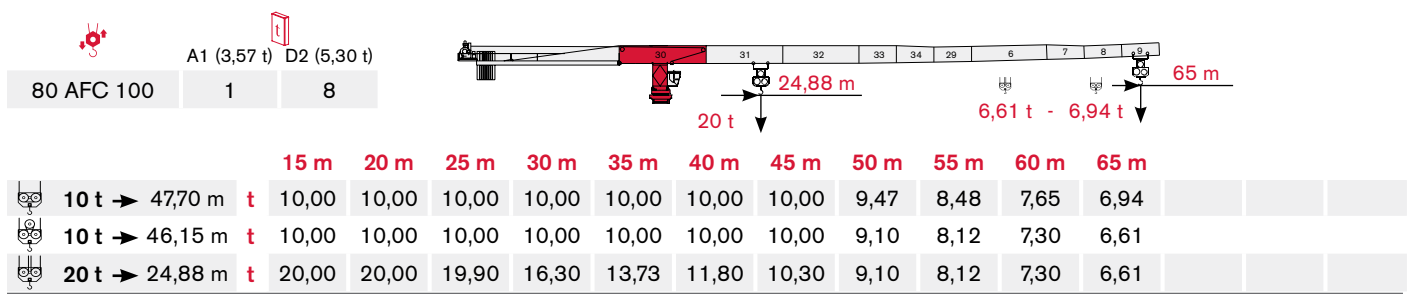
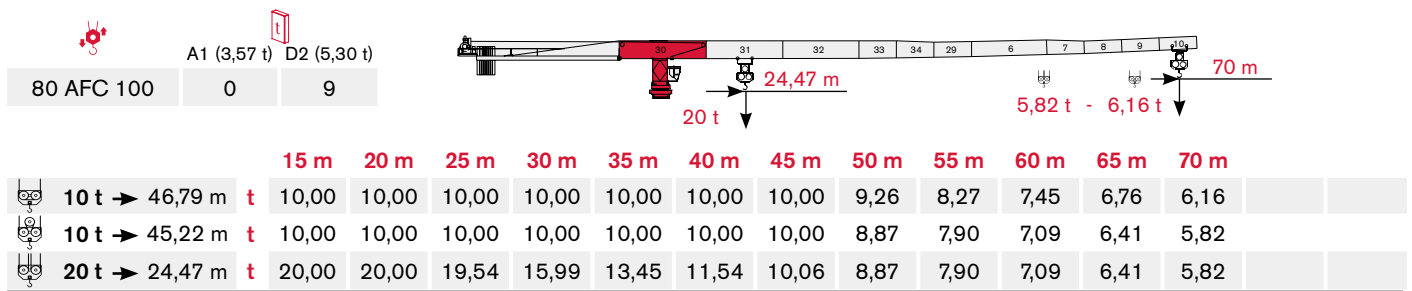
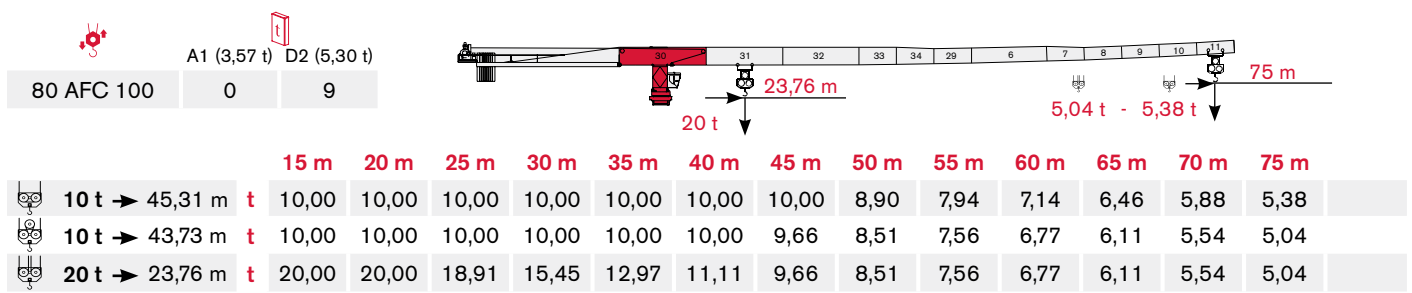
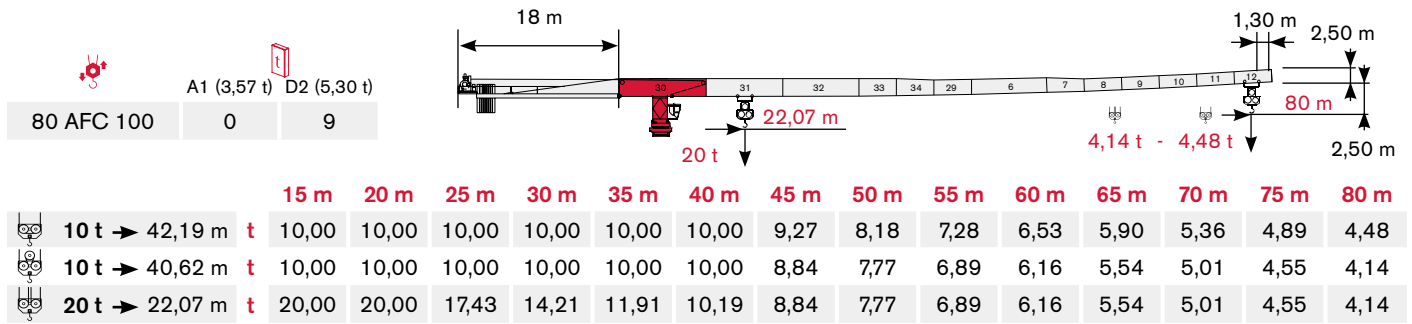

80 AFC 100    A1 (3,57 t) D2 (5,30 t)  
 1    7

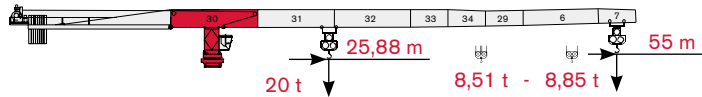

	15 m	20 m	25 m	30 m	35 m	40 m	45 m	50 m	55 m
10 t →	49,48 m	10,00	10,00	10,00	10,00	10,00	10,00	9,88	8,85
10 t →	48,00 m	10,00	10,00	10,00	10,00	10,00	10,00	9,53	8,51
20 t →	25,88 m	20,00	20,00	20,00	17,02	14,35	12,34	10,78	9,53

80 AFC 100    A1 (3,57 t) D2 (5,30 t)  
 0    7

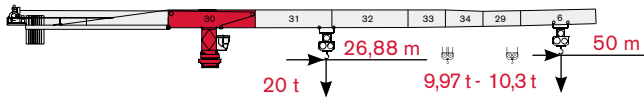

	15 m	20 m	25 m	30 m	35 m	40 m	45 m	50 m
10 t →	51,32 m	10,00	10,00	10,00	10,00	10,00	10,00	10,30
10 t →	49,86 m	10,00	10,00	10,00	10,00	10,00	10,00	9,97
20 t →	26,88 m	20,00	20,00	20,00	17,74	14,97	12,88	11,26

80 AFC 100    A1 (3,57 t) D2 (5,30 t)  
 0    6

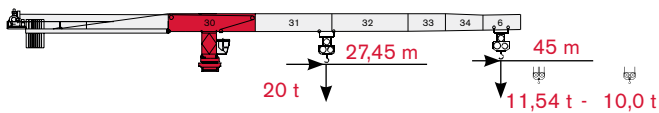

	15 m	20 m	25 m	30 m	35 m	40 m	45 m
10 t →	45,00 m	10,00	10,00	10,00	10,00	10,00	10,00
10 t →	45,00 m	10,00	10,00	10,00	10,00	10,00	10,00
20 t →	27,45 m	20,00	20,00	20,00	18,15	15,32	13,19

80 AFC 100    A1 (3,57 t) D2 (5,30 t)  
 1    5

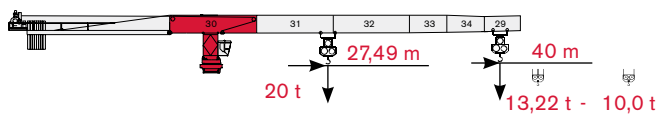

	15 m	20 m	25 m	30 m	35 m	40 m
10 t →	40,00 m	10,00	10,00	10,00	10,00	10,00
10 t →	40,00 m	10,00	10,00	10,00	10,00	10,00
20 t →	27,49 m	20,00	20,00	20,00	18,19	15,35

80 AFC 100    A1 (3,57 t) D2 (5,30 t)  
 0    5

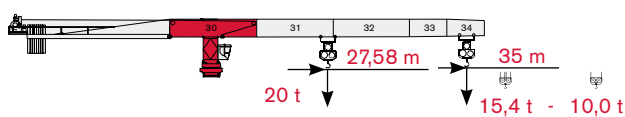

	15 m	20 m	25 m	30 m	35 m
10 t →	35,00 m	10,00	10,00	10,00	10,00
10 t →	35,00 m	10,00	10,00	10,00	10,00
20 t →	27,58 m	20,00	20,00	20,00	18,25

80 AFC 100    A1 (3,57 t) D2 (5,30 t)  
 0    4

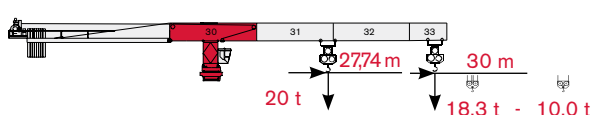

	15 m	20 m	25 m	30 m
10 t →	30,00 m	10,00	10,00	10,00
10 t →	30,00 m	10,00	10,00	10,00
20 t →	27,74 m	20,00	20,00	18,37

# TOWER

Turn · Tour · Torre · Torre · Torre · Башня

Standard Configurations · Standardkonfiguration · Standard Implantations ·  
 Implantaciones Standard · Installazioni Standard · Configuração padrão ·  
 Стандартная конфигурация крана

## H20

Tower: H20 & Basement: RTL

	●	◊
R1	-3470 kN	-2950 kN
R2	2575 kN	2264 kN
	1003 kN	

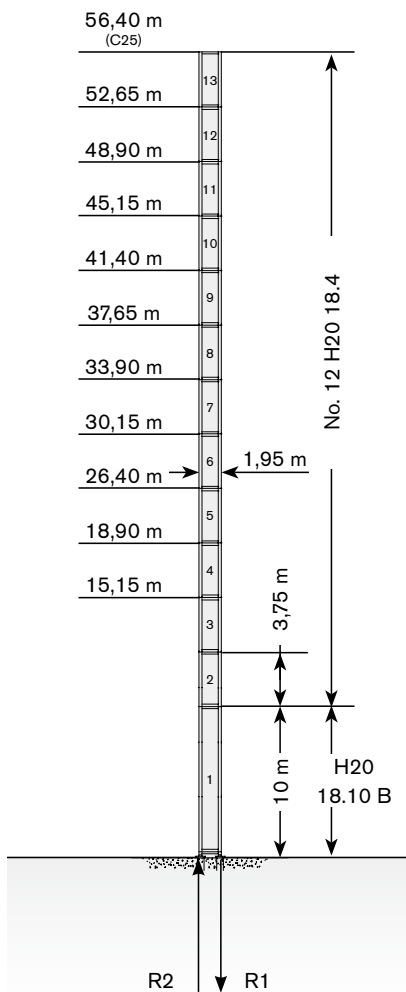

→	max. H (m)	
	FEM 1001	FEM 1005 C25
30->50 m	56,40	56,40
55->80 m	56,40	56,40

Tower: H20 & Basement: FTR

	●	◊
R1	-1723 kN	-1550 kN
R2	0 kN	0 kN
	1051 kN	

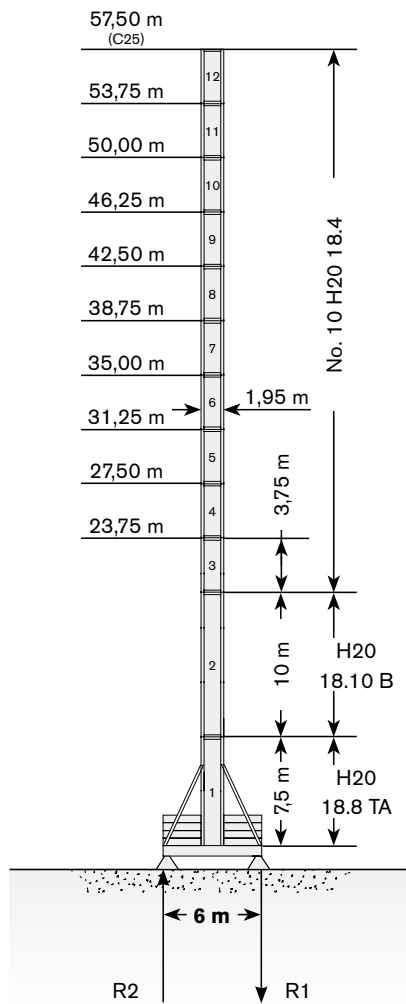

→	max. H (m)	
	FEM 1001	FEM 1005 C25
30->50 m	57,50	57,50
55->80 m	53,75	53,75

Tower: H20 & Basement: TTR

	●	◊
R1	-1738 kN	-1259 kN
R2	0 kN	-35 kN
	964 kN	

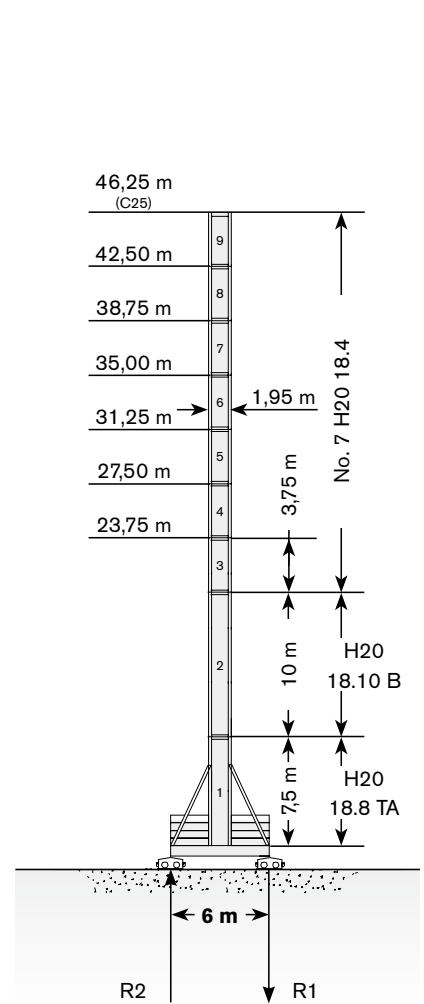

→	max. H (m)	
	FEM 1001	FEM 1005 C25
30->50 m	46,25	46,25
55->80 m	46,25	46,25

Max. under hook height · Höchste Hakenhöhe · Hauteur maxi. sous crochet · Maxima altura bajo gancho · Altezza max. sotto gancio · alt. máx. sob o gancho · макс высота крюка

Different heights and tower combinations are available; please consult us · Andere Höhen und Turmkombinationen auf Anfrage · Différentes hauteurs et combinaisons de tour sont disponibles; nous consulter · Hay diferentes alturas y combinaciones de torre disponibles. Consultémos · Altezze diverse e combinazioni di torre sono disponibili; consultateci · Diferentes alturas e combinações de torres disponíveis; fale conosco · Возможны другие сочетания высоты и конфигурации башни; проконсультируйтесь с нами



## Other configurations · Aufstellmöglichkeiten · Autres Implantations · Otras Implantaciones · Altre Installazioni · Outras configurações · Другие конфигурации

Bottom climbing crane · Kletterkran im Gebäude · Télescopage sur dalles · Telescopage grúa trepadora · Gru climbing · Guindaste automontante interno · Самоподъемный кран

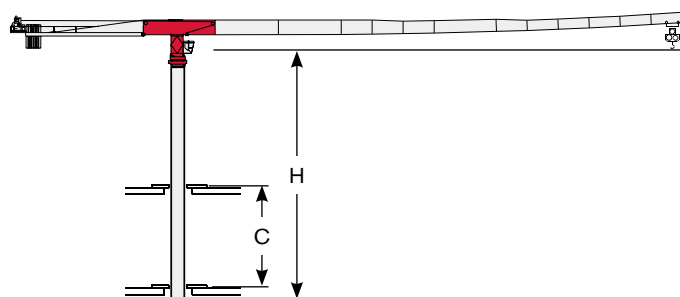

Crane tied to the structure · Geankerter Kran · Grue ancrée · Grúa anclada · Gru ancorata · Guindaste ancorado na estrutura · Кран, крепящийся к сооружению

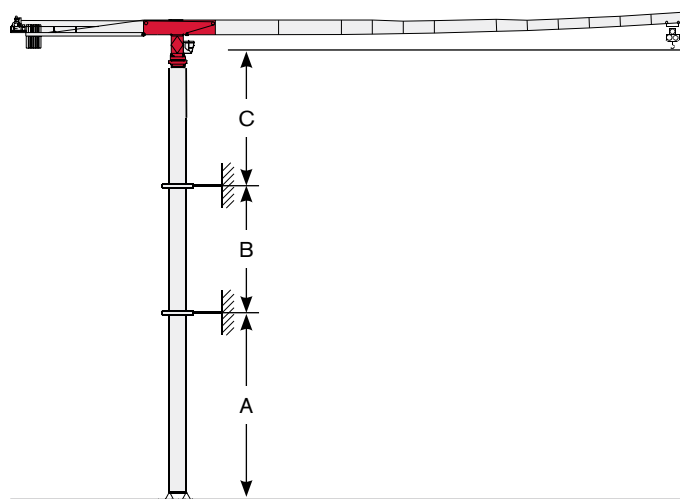

**Tower: H20**

Jib (m)	C min/max (m)	H min/max (m)
30 > 50	12/16	30/41,25
55 > 80	12/16	30/37,5

**Tower: H20 & Basement: RTL**

Jib (m)	A min/max (m)	B min/max (m)	C max (m)
all	25/44	18/24	32



Different heights and tower combinations are available; please consult us · Andere Höhen und Turmkombinationen auf Anfrage · Différentes hauteurs et combinaisons de tour sont disponibles; nous consulter · Hay diferentes alturas y combinaciones de torre disponibles. Consultémos · Altezze diverse e combinazioni di torre sono disponibili; consultateci · Diferentes alturas e combinações de torres disponíveis; fale conosco · Возможны другие сочетания высоты и конфигурации башни; проконсультируйтесь с нами

# TOWER

Turn · Tour · Torre · Torre · Torre · Башня

Standard Configurations · Standardkonfiguration · Standard Implantations ·  
 Implantaciones Standard · Installazioni Standard · Configuração padrão ·  
 Стандартная конфигурация крана

## HD23

Tower: HD23 & Basement: FP1

	●	◊
R1	-1611 kN	-1760 kN
R2	0 kN	0 kN
	1316 kN	

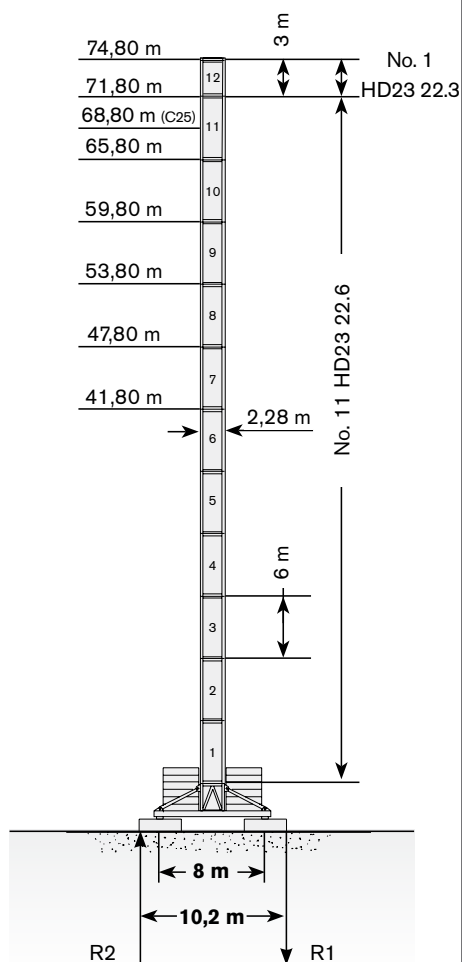

→	max. H (m)	
	FEM 1001	FEM 1005 C25
30->50 m	74,80	68,80
55->80 m	74,80	68,80

Tower: HD23 & Basement: T1

	●	◊
R1	-1598 kN	-1401 kN
R2	0 kN	0 kN
	1248 kN	

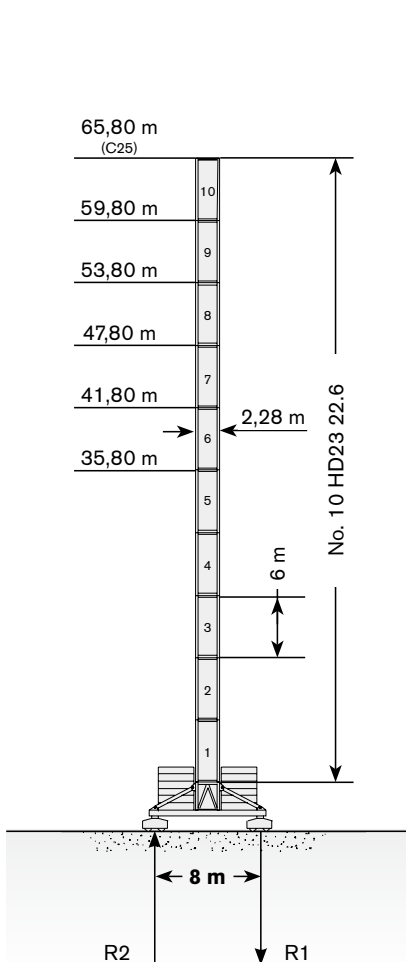

→	max. H (m)	
	FEM 1001	FEM 1005 C25
30->50 m	65,80	65,80
55->80 m	62,80	62,80

Tower: HD23 & Basement: R1

	●	◊
R1	-3610 kN	-3809 kN
R2	2636 kN	2998 kN
	1146 kN	

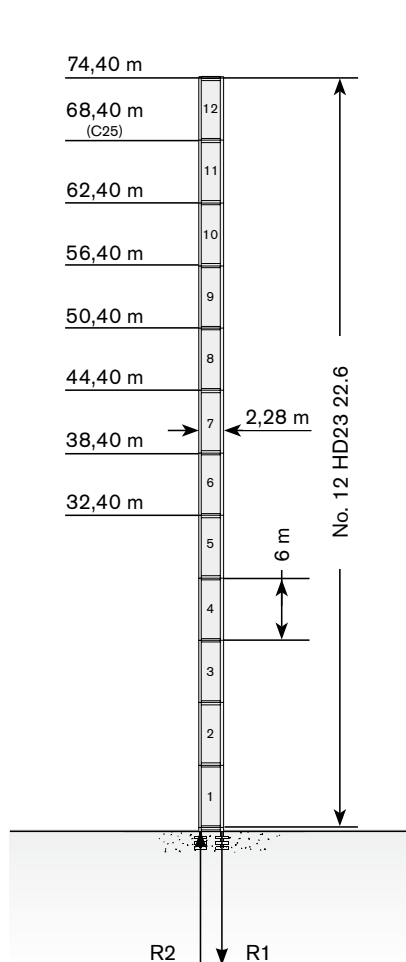

→	max. H (m)	
	FEM 1001	FEM 1005 C25
30->50 m	74,40	68,40
55->80 m	74,40	68,40

Max. under hook height · Höchste Hakenhöhe · Hauteur maxi. sous crochet · Maxima altura bajo gancho · Altezza max. sotto gancio ·  
 Alt. máx. sob o gancho · макс высота крюка

Different heights and tower combinations are available; please consult us · Andere Höhen und Turmkombinationen auf Anfrage · Différentes hauteurs et combinaisons de tour sont disponibles; nous consulter · Hay diferentes alturas y combinaciones de torre disponibles. Consultémos · Altezze diverse e combinazioni di torre sono disponibili; consultateci · Diferentes alturas e combinações de torres disponíveis; fale conosco · Возможны другие сочетания высоты и конфигурации башни; проконсультируйтесь с нами



**Tower: HD23 & Basement: R2**

	●	◆
<b>R1</b>	-4149 kN	-5316 kN
<b>R2</b>	3101 kN	4460 kN
	1287 kN	

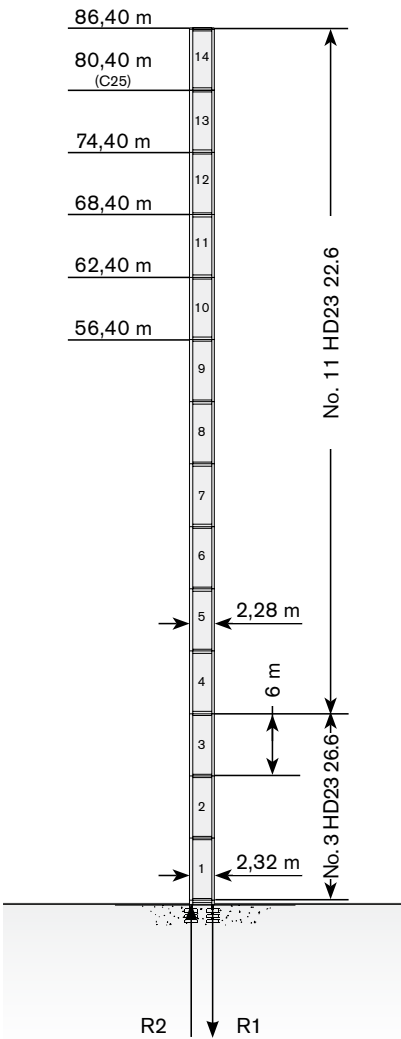

→	max. H (m)	
	FEM 1001	FEM 1005 C25
30->50 m	86,40	80,40
55->80 m	86,40	80,40

**Tower: HD23 & Basement: FP2**

	●	◆
<b>R1</b>	-1611 kN	-2023 kN
<b>R2</b>	-50 kN	0 kN
	1586 kN	

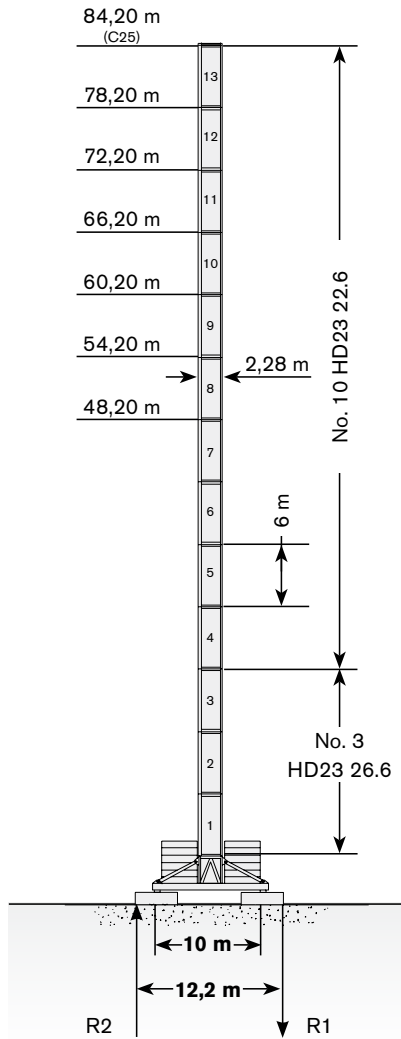

→	max. H (m)	
	FEM 1001	FEM 1005 C25
30->50 m	84,20	84,20
55->80 m	84,20	78,20

**Tower: HD23 & Basement: T2**

	●	◆
<b>R1</b>	-1761 kN	-2026 kN
<b>R2</b>	0 kN	0 kN
	1599 kN	

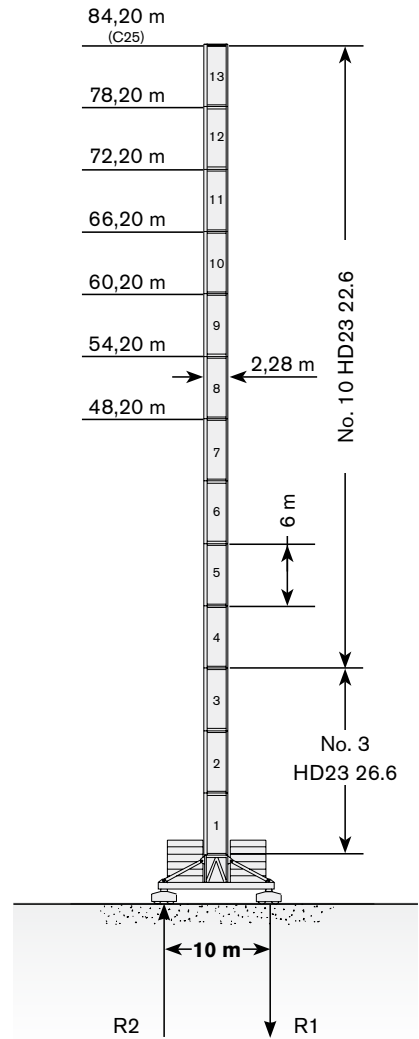

→	max. H (m)	
	FEM 1001	FEM 1005 C25
30->50 m	84,20	84,20
55->80 m	84,20	78,20

# TOWER

Turn · Tour · Torre · Torre · Torre · Башня

Standard Configurations · Standardkonfiguration · Standard Implantations ·  
 Implantaciones Standard · Installazioni Standard · Configuração padrão ·  
 Стандартная конфигурация крана

## HD23

Tower: HD23 & Basement: R3

	●	◆
R1	-4345 kN	-6592 kN
R2	3244 kN	5732 kN
	1398 kN	

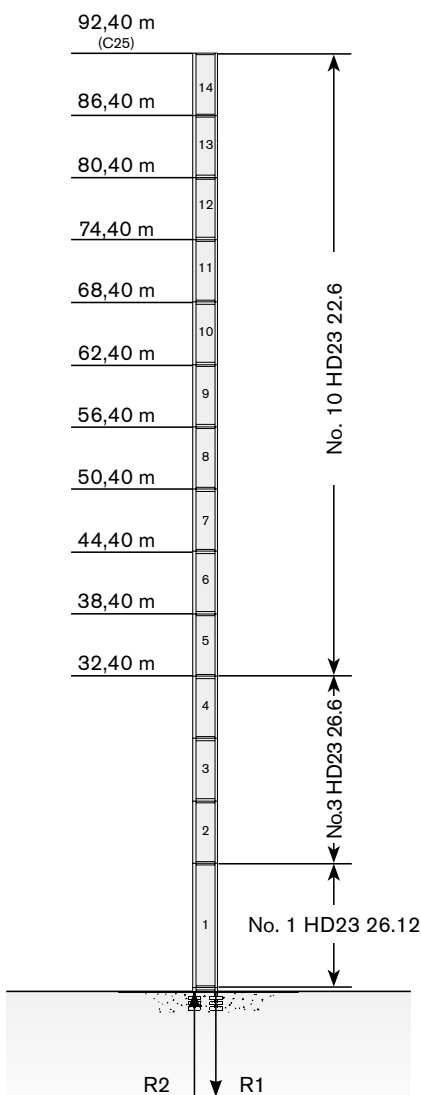

→ 	max. H (m)	
	FEM 1001	FEM 1005 C25
30->50 m	92,40	92,40
55->80 m	92,40	86,40

Max. under hook height · Höchste Hakenhöhe · Hauteur maxi. sous crochet · Maxima altura bajo gancho · Altezza max. sotto gancio ·  
 Alt. máx. sob o gancho · макс высота крюка

Different heights and tower combinations are available; please consult us · Andere Höhen und Turmkombinationen auf Anfrage · Différentes hauteurs et combinaisons de tour sont disponibles; nous consulter · Hay diferentes alturas y combinaciones de torre disponibles. Consúltenos · Altezze diverse e combinazioni di torre sono disponibili; consultateci · Diferentes alturas e combinações de torres disponíveis; fale conosco · Возможны другие сочетания высоты и конфигурации башни; проконсультируйтесь с нами



## Other configurations · Aufstellmöglichkeiten · Autres Implantations · Otras Implantaciones · Altre Installazioni · Outras configurações · Другие конфигурации

Bottom climbing crane · Kletterkran im Gebäude · Télescopage sur dalles · Telescopage grúa trepadora · Gru climbing · Guindaste automontante interno · Самоподъемный кран

Crane tied to the structure · Geankerter Kran · Grue ancrée · Grúa anclada · Gru ancorata · Guindaste ancorado na estrutura · Кран, крепящийся к сооружению

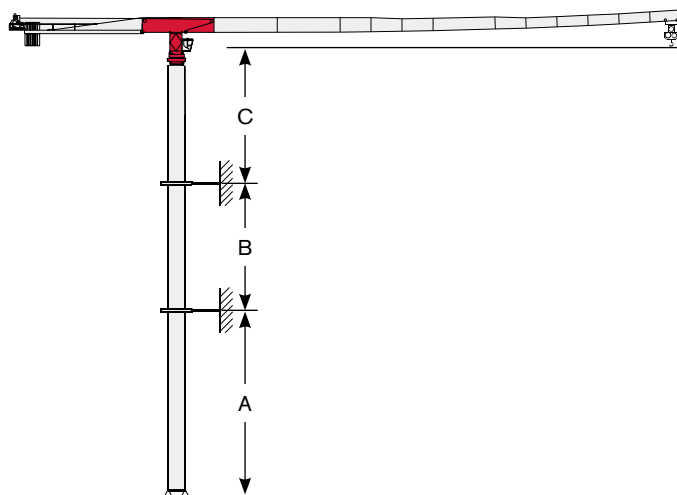
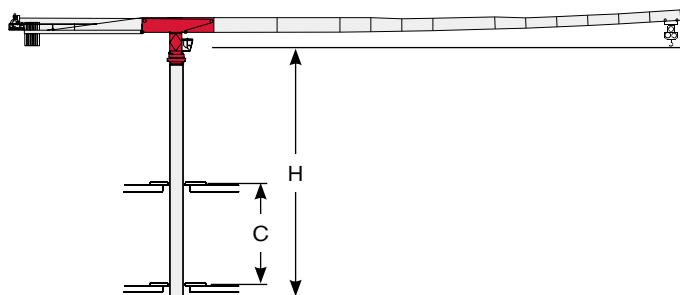

**Tower: HD23**

Jib (m)	C min/max (m)	H min/max (m)
all	10/16	36/54

**Tower: HD23 & Basement: R2**

Jib (m)	A min/max (m)	B min/max (m)	C max (m)
all	42/66	24/42	42







Different heights and tower combinations are available; please consult us · Andere Höhen und Turmkombinationen auf Anfrage · Différentes hauteurs et combinaisons de tour sont disponibles; nous consulter · Hay diferentes alturas y combinaciones de torre disponibles. Consultenos · Altezze diverse e combinazioni di torre sono disponibili; consultateci · Diferentes alturas e combinações de torres disponíveis; fale conosco · Возможны другие сочетания высоты и конфигурации башни; проконсультируйтесь с нами

# MECHANISMS





Antriebe · Mécanismes · Mecanismos · Meccanismi · Mecanismo · Механизм

Power supply · Stromversorgung · Alimentation · Suministro eléctrico · Alimentazione · Requisitos de energia · Требования по питанию

	80 AFC 100	 186 kVA*	 400V - 50Hz / 460V - 60Hz	 2000/14/CE modificata
---	------------	--	---	---

\* Average consumption · Durchschnittsverbrauch · Consommation moyenne · Consumo medio · Consumo medio · Consumo médio · Среднее потребление

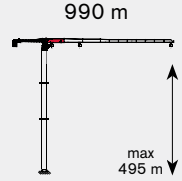

Hoisting · Heben · Levage · Elevación · Sollevamento · Elevação · Подъем

			t	m/min	kW	
	80 AFC 100 D2		10	0 → 38	80	
			8,5	0 → 45		
			5,5	0 → 64		
			3,5	0 → 90		
			0,7	0 → 190		
			20	0 → 19		
			17	0 → 22		
			11	0 → 32		
			7	0 → 45		
			1,4	0 → 95		

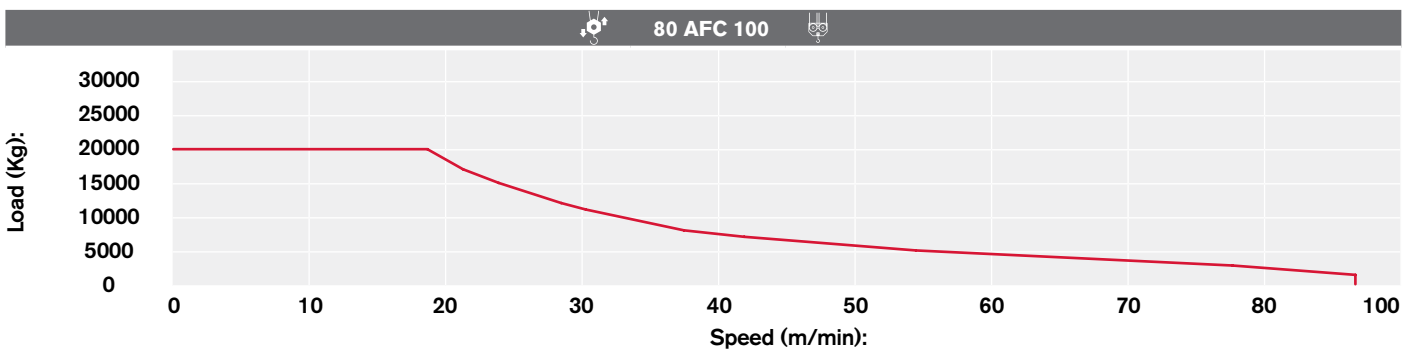
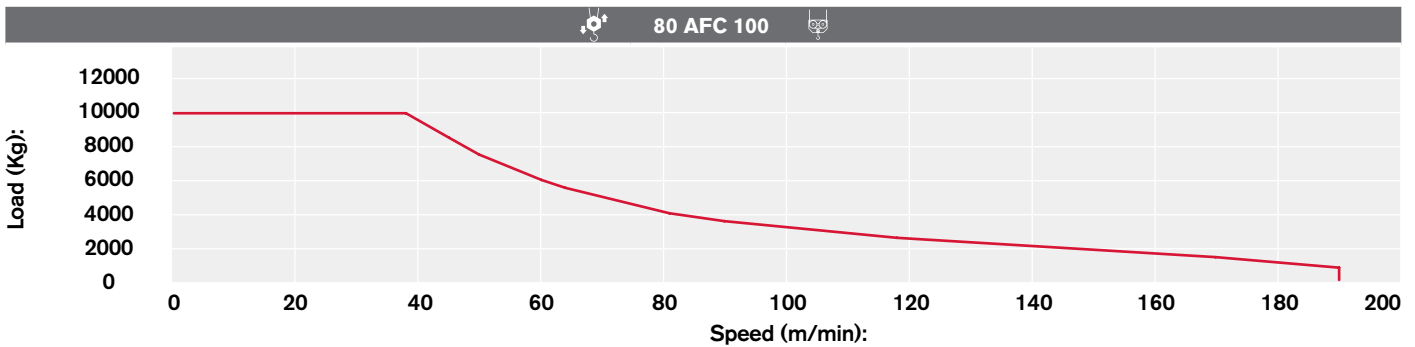

Hoisting Speed · Heben Geschwindigkeit · Vitesse de Levage · Velocidad de Elevación · Velocità di Sollevamento · Velocidade de içamento · Скорость подъема

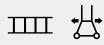
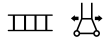

## Additional Specifications · Weitere Leistungsdaten · Spécifications additionnelles · Otras prestaciones · Altre movimentazioni · Especificações adicionais · Дополнительные спецификации

	DVF 5 15 D5	0 → 12,5 → 47 → 110 m/min	15 kW
	SVF 2 2 19	0,9 r.p.m.	2 x 18,5 kW
	TSR 2RG 4M8	12 → 24 m/min (50 Hz) 14 → 28 m/min (60 Hz)	4 x 80 Nm
	TSR 4RG 4M8	12 → 24 m/min (50 Hz) 14 → 28 m/min (60 Hz)	4 x 80 Nm

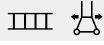
### Tower height max.









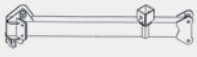

		T1	T2	T2 C25
	TSR 2RG 4M8	35,6 m	48 m	42 m
	TSR 4RG 4M8	> 35,6 m	> 48 m	> 42 m

# TRANSPORTATION



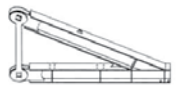

Transport · Transport · Transporte · Trasporto · Transporte · Транспортировка

## Packing list

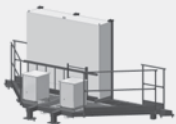

### Undercarriage

CTT 472-20 H20	DESCRIPTION · BESCHREIBUNG · DESCRIPTION · DESCRIPCIÓN · DESCRIZIONE · DESCRIÇÃO · ОПИСАНИЕ	LENGTH · LÄNGE · LONGUEUR · LONGITUD · LUNGHEZZA · COMPRIMENTO · ДЛИНА	WIDTH · BREITE · LARGEUR · ANCHURA · LARGHEZZA · LARGURA · ШИРИНА	HEIGHT · HÖHE · HAUTEUR · ALTURA · ALTEZZA · ALTURA · ВЫСОТА	QUANTITY · MENGE · QUANTITÉ · CANTIDAD · CANTITÀ · QUANTIDADE · КОЛИЧЕСТВО	WEIGHT · GEWICHT · POIDS · PESO · PESO · ВЕС
	STRUT MOUNTING TOWER SECTION H20 18.8TA FOR 6x6 m UNDERCARRIAGE	7,50 m	2,30 m	2,30 m	1	6660 kg*
	6x6 m UNDERCARRIAGE LONG BEAM	8,95 m	0,50 m	1,05 m	1	2088 kg
	6x6 m UNDERCARRIAGE SHORT BEAM	4,4 m	0,5 m	1,05 m	2	1010 kg
	6x6 m UNDERCARRIAGE JOINING SLEEPER	5,5 m	0,15 m	0,48 m	2	280 kg
	6x6 m UNDERCARRIAGE JOINING SLEEPER	5,5 m	0,15 m	0,48 m	2	220 kg
	6x6 m UNDERCARRIAGE STRUT	5,10 m	0,24 m	0,30 m	4	500 kg
<b>CTT 472-20 HD23</b>						
	8x8 m UNDERCARRIAGE STRUT MOUNTING TOWER SECTION	2,90 m	2,90 m	2,90 m	1	9150 kg
	8x8 m UNDERCARRIAGE STRUT	4,30 m	0,30 m	2,25 m	4	1820 kg
	8x8 m UNDERCARRIAGE INTERNAL BEAM	4,00 m	0,16 m	0,33 m	4	210 kg
	8x8 m UNDERCARRIAGE EXTERNAL BEAM	5,96 m	0,30 m	0,33 m	4	626 kg
	10x10 m UNDERCARRIAGE STRUT MOUNTING TOWER SECTION	3,00 m	3,00 m	3,10 m	1	10450 kg



CTT 472-20 HD23	DESCRIPTION · BESCHREIBUNG · DESCRIPTION · DESCRIPCIÓN · DESCRIZIONE · DESCRIÇÃO · ОПИСАНИЕ	LENGTH · LÄNGE · LONGUEUR · LONGITUD · LUNGHEZZA · COMPRIMENTO · ДЛИНА	WIDTH · BREITE · LARGEUR · ANCHURA · LARGHEZZA · LARGURA · ШИРИНА	HEIGHT · HÖHE · HAUTEUR · ALTURA · ALTEZZA · ALTURA · ВЫСОТА	QUANTITY · MENGE · QUANTITÉ · CANTIDAD · QUANTITÀ · QUANTIDADE · КОЛИЧЕСТВО	WEIGHT · GEWICHT · POIDS · PESO · PESO · ВЕС
	10x10 m LEFT + RIGHT UNDERCARRIAGE STRUT	5,70 m	2,60 m	0,70 m	2 left + 2 right	3825 kg
	CROSSBEAM FOR TRAVELLING 10x10 m UNDERCARRIAGE	7,00 m	2,20 m	0,40 m	2	2030 kg
	10x10 m UNDERCARRIAGE ELECTRICAL BOX SUPPORT PLATFORM FOR TVF 4RT 4M9 TRAVELLING DRIVE UNIT	5,70 m	2,20 m	2,40 m	1	1300 kg
	10x10 m UNDERCARRIAGE ELECTRICAL BOX SUPPORT PLATFORM FOR TSR 4RG 4M8 TRAVELLING DRIVE UNIT	5,60 m	2,10 m	3,70 m	1	645 kg

## Tower

CTT 472-20 H20						
	H20 18.10 B TOWER SECTION	10,0 m	2,00 m	1,95 m	1	7000 kg*
	H20 18.4 TOWER SECTION	3,75 m	2,00 m	1,95 m	1	2955 kg*













\* inclusive of ladders, platforms and assembly equipment

# TRANSPORTATION

Transport · Transport · Transporte · Trasporto · Transporte · Транспортировка

CTT 472-20 HD23	DESCRIPTION · BESCHREIBUNG · DESCRIPTION · DESCRIPCIÓN · DESCRIZIONE · DESCRIÇÃO · ОПИСАНИЕ	LENGTH · LÄNGE · LONGUEUR · LONGITUD · LUNGHEZZA · COMPRIMENTO · ДЛИНА	WIDTH · BREITE · LARGEUR · ANCHURA · LARGHEZZA · LARGURA · ШИРИНА	HEIGHT · HÖHE · HAUTEUR · ALTURA · ALTEZZA · ALTURA · ВЫСОТА	QUANTITY · MENGE · QUANTITÉ · CANTIDAD · QUANTITÀ · QUANTIDADE · КОЛИЧЕСТВО	WEIGHT · GEWICHT · POIDS · PESO · PESO · ВЕС
	TOWER SECTION HD23 26.6	6,00 m	2,34 m	2,32 m	1	6300 kg*
	TOWER SECTION HD23 26.3	3,00 m	2,34 m	2,32 m	1	3658 kg
	TOWER SECTION HD23 22.6	6,00 m	2,28 m	2,29 m	1	4675 kg*
	TOWER SECTION HD23 22.3	3,00 m	2,29 m	2,28 m	1	2660 kg*
	SLEWING UNIT CTT472-20 HD23	3,00 m	2,30 m	2,40 m	1	10450 kg
	SLEWING UNIT PLATFORM	2,30 m	0,70 m	1,50 m	1	132 kg
<b>Cab</b>						
CTT 472-20						
	CAB PLATFORM	5,10 m	1,90 m	2,30 m	1	1852 kg
	CAB MAST	3,60 m	2,00 m	2,00 m	1	2650 kg
<b>Upper Part</b>						
CTT 472-20						
	COUNTER JIB	9,80 m	2,10 m	2,30 m	1	3865 kg
	WINCH COUNTERJIB 80 AFC 100 D2	3,67 m	2,20 m	2,46 m	1	R01 6200 kg** R02 5600 kg**
	COUNTER JIB PLATFORMS UNIT	3,50 m	0,80 m	0,40 m	1	782 kg

## Upper Part

CTT 472-20	DESCRIPTION · BESCHREIBUNG · DESCRIPTION · DESCRIPCIÓN · DESCRIZIONE · DESCRIÇÃO · ОПИСАНИЕ	LENGTH · LÄNGE · LONGUEUR · LONGITUD · LUNGHEZZA · COMPRIMENTO · ДЛИНА	WIDTH · BREITE · LARGEUR · ANCHURA · LARGHEZZA · LARGURA · ШИРИНА	HEIGHT · HÖHE · HAUTEUR · ALTURA · ALTEZZA · ALTURA · ВЫСОТА	QUANTITY · MENGE · QUANTITÉ · CANTIDAD · QUANTITÀ · QUANTIDADE · КОЛИЧЕСТВО	WEIGHT · GEWICHT · POIDS · PESO · PESO · ВЕС
	JIB SECTION - 30	12,00 m	2,20 m	2,60 m	1	10000 kg
	JIB SECTION - 31	10,50 m	1,90 m	2,50 m	1	4700 kg
	JIB SECTION - 32	10,00 m	1,90 m	2,50 m	1	3750 kg
	JIB SECTION - 33	5,00 m	1,90 m	2,50 m	1	1750 kg
	JIB SECTION - 34	5,00 m	1,90 m	2,50 m	1	1615 kg
	JIB SECTION - 29	5,00 m	1,90 m	2,30 m	1	1532 kg
	JIB SECTION - 06	10,30 m	1,90 m	2,20 m	1	1915 kg
	JIB SECTION - 07	5,28 m	1,90 m	2,18 m	1	900 kg
	JIB SECTION - 08	5,25 m	1,87 m	1,86 m	1	780 kg
	JIB SECTION - 09	5,20 m	1,87 m	1,86 m	1	640 kg
	JIB SECTION - 10	5,20 m	1,90 m	1,86 m	1	510 kg
	JIB SECTION - 11	5,20 m	1,90 m	1,90 m	1	452 kg
	JIB SECTION - 12	5,20 m	1,90 m	1,80 m	1	380 kg
	JIB POINT	2,10 m	1,20 m	1,60 m	1	270 kg
	TROLLEY	2,40 m	2,30 m	1,50 m	1	672 kg
	HOIST BLOCK UNIT	1,60 m	0,60 m	1,65 m	1	887 kg max

\* inclusive of ladders, platforms and assembly equipment

\*\* without rope

Effective Date: September 2017.

Product specifications and prices are subject to change without notice or obligation. The photographs and/or drawings in this document are for illustrative purposes only. Refer to the appropriate Operator's Manual for instructions on the proper use of this equipment. Failure to follow the appropriate Operator's Manual when using our equipment or to otherwise act irresponsibly may result in serious injury or death. The only warranty applicable to our equipment is the standard written warranty applicable to the particular product and sale and Terex makes no other warranty, express or implied. Products and services listed may be trademarks, service marks or trade-names of Terex Corporation and/or its subsidiaries in the USA and other countries. All rights are reserved. Terex® is a registered trademark of Terex Corporation in the USA and many other countries.

Gültig ab: September 2017.

Produktbeschreibungen und Preise können jederzeit und ohne Verpflichtung zur Ankündigung geändert werden. Die in diesem Dokument enthaltenen Fotos und/oder Zeichnungen dienen rein anschaulichen Zwecken. Anweisungen zur ordnungsgemäßen Verwendung dieser Ausrüstung entnehmen Sie bitte dem zugehörigen Betriebshandbuch. Nichtbefolgung des Betriebshandbuchs bei der Verwendung unserer Produkte oder anderweitig fahrlässiges Verhalten kann zu schwerwiegenden Verletzungen oder Tod führen. Für dieses Produkt wird ausschließlich die entsprechende, schriftlich niedergelegte Standardgarantie gewährt. Terex leistet keinerlei darüber hinaus gehende Garantie, weder ausdrücklich noch stillschweigend. Die Bezeichnungen der aufgeführten Produkte und Leistungen sind gegebenenfalls Marken, Servicemarken oder Handelsnamen der Terex Corporation und/oder ihrer Tochtergesellschaften in den USA und anderen Ländern. Alle Rechte vorbehalten. „TEREX“ ist eine eingetragene Marke der Terex Corporation in den USA und vielen anderen Ländern.

Date d'effet : Septembre 2017.

Les spécifications et prix des produits sont sujets à modification sans avis ou obligation. Les photographies et/ou dessins contenus dans ce documents sont uniquement pour illustration. Veuillez vous référer à la notice d'utilisation appropriée pour les instructions quant à l'utilisation correcte de cet équipement. Tout manquement au suivi de la notice d'utilisation appropriée lors de l'utilisation de notre équipement ou tout acte autrement irresponsable peut résulter en blessure corporelle sérieuse ou mortelle. La seule garantie applicable à notre équipement est la garantie standard écrite applicable à un produit et à une vente spécifique. Terex n'offre aucune autre garantie, expresse ou implicite. Les produits et services proposés peuvent être des marques de fabrique, des marques de service ou des appellations commerciales de Terex Corporation et/ou ses filiales aux Etats Unis et dans les autres pays, et tous les droits sont réservés. «TEREX» est une marque déposée de Terex Corporation aux Etats Unis et dans de nombreux autres pays.

Fecha efectiva: Septiembre 2017.

Los precios y las especificaciones de productos pueden sufrir cambios sin aviso previo u obligación. Las fotografías o dibujos de este documento tienen un fin meramente ilustrativo. Consulte el manual de instrucciones del operador correspondiente para más información sobre el uso correcto de este equipo. El hecho de no respetar el manual del operador correspondiente al utilizar el equipo o actuar de forma irresponsable puede suponer lesiones graves o fatales. La única garantía aplicable a nuestro equipo es la garantía escrita estándar correspondiente a cada producto y venta, y TEREX no amplía dicha garantía de forma expresa o implícita. Los productos y servicios mencionados pueden ser marcas registradas, marcas de servicio o nombres de marca de TEREX Corporation o de sus filiales en Estados Unidos de América y otros países, y se reservan todos los derechos. „TEREX“ es una marca comercial registrada de Terex Corporation en Estados Unidos de América y muchos otros países.

Data di inizio validità: Settembre 2017.

Ci riserviamo il diritto di modificare le specifiche e i prezzi dei prodotti in ogni momento e senza preavviso. Le fotografie e/o i disegni contenuti in questo documento sono destinati unicamente a scopi illustrativi. Consultare le istruzioni sull'uso corretto di questo macchinario, contenute nell'opportuno Manuale dell'operatore. L'inottemperanza delle istruzioni contenute nel Manuale dell'operatore del macchinario e altri comportamenti irresponsabili possono provocare gravi lesioni, anche mortali. L'unica garanzia applicabile ai nostri macchinari è la garanzia scritta standard applicabile al particolare prodotto e alla particolare vendita; Terex è esonerata dal fornire qualsiasi altra garanzia, esplicita o implicita. I prodotti e servizi elencati possono essere dei marchi di fabbrica, marchi di servizio o nomi commerciali di TEREX Corporation e/o società affiliate negli Stati Uniti d'America e altre nazioni e tutti i diritti sono riservati. „TEREX“ è un marchio registrato di Terex Corporation negli USA e molti altri Paesi.

Data de vigência: Setembro 2017.

Especificações e preços dos produtos sujeitos a alteração sem aviso prévio ou obrigações. As fotografias e/ou desenhos deste documento servem apenas para fins ilustrativos. Consulte o respectivo Manual de Instruções para instruções sobre o uso correto deste equipamento. A falta de atenção ao respectivo Manual do Operador no uso de nosso equipamento ou a operação da máquina em condições impróprias pode resultar em lesão grave ou morte. A única garantia aplicável aos nossos equipamentos é a garantia padrão por escrito, aplicável ao produto específico e à sua venda, sem que nenhuma outra, expressa ou implícita, seja oferecida pela Terex. Os produtos e serviços listados podem ser marcas comerciais, marcas de serviço ou nomes-fantasia da Terex Corporation e/ou suas subsidiárias nos EUA e em outros países. Todos os direitos reservados. Terex® é marca registrada da Terex Corporation nos EUA e muitos outros países.

Вступает в силу: Сентябрь 2017.

Технические характеристики и цены могут изменяться без предварительного уведомления и без каких-либо обязательств для производителя. Фотографии и (или) чертежи, использованные в документе, приведены исключительно в качестве иллюстраций. Инструкции по правилам эксплуатации даются в соответствующих руководствах для операторов данного оборудования. Невыполнение рекомендаций руководства по эксплуатации нашего оборудования или другие безответственные действия могут повлечь серьезные травмы или смерть. Единственной гарантией, действующей в отношении нашего оборудования, является стандартная форма письменной гарантии на данный тип оборудования и на условия его продажи.



Copyright 2017 Terex Corporation

Terex Cranes, Global Marketing, Dinglerstraße 24, 66482 Zweibrücken, Germany  
Tel. +49 (0) 6332 830, Email: info.cranes@terex.com, www.terexcranes.com

Brochure Reference: TC-DS-M-E/F/G//S/P/R-CTT 472-20-09/17

[www.terexcranes.com](http://www.terexcranes.com)



WORKS FOR YOU.™